



ExCos-D Transmitter for ExPro-C... Temperature / humidity sensors

ExCos - D
ExCos - D - A
ExCos - ... - CT
ExCos - ... - VA

Subject to change!

Electrical, explosion-proof transmitters with ExPro-C... sensors
24 VAC/DC supply voltage, (0)4...20 mA/0...10 V analogue output
EC type-approved in acc. with ATEX directive 2014/34/EU for zone 1, 2, 21, 22

Compact. Easy installation. Universal. Cost effective. Safe.

Type	Sensors (compulsory)	Function of sensors	Supply	Output	Ex-i output	Wiring diagram	Installation area
ExCos- D	ExPro-C... (see below)	°C, % rH, °C+% rH	24 VAC/DC	(0)4...20 mA / 0...10 V	–	SB 2.0	Zone 1, 2, 21, 22
ExCos- D - A	as above with 2 additional intrinsically safe analogue output to connect an external digital indicator				2 × (0)4...20 mA	SB 3.2	Zone 1, 2, 21, 22
ExCos- D... - CT	Types as above with aluminium housing and seawater resistant coating (cable glands M16 brass nickel-plated, screws in stainless steel)						
ExCos- D... - VA	Types as above with stainless steel housing for aggressive ambient (cable glands M20 brass nickel-plated, screws in stainless steel)						

Type	Function	Range	Probe/sensor length	Connection	Installation area sensor
ExPro-CT-...	Temperature sensor	-40...+125 °C*	50 / 100 / 150 / 200 mm	Plug and socket to ExCos-D..., RedCos-D...	Zone 1, 2, 21, 22
ExPro-CF-...	Humidity sensor	0...100 % rH	50 / 100 / 150 / 200 mm	Plug and socket to ExCos-D..., RedCos-D...	Zone 1, 2, 21, 22
ExPro-CTF-...	Combination sensor	-40...+125 °C* / 0...100 % rH	50 / 100 / 150 / 200 mm	Plug and socket to ExCos-D..., RedCos-D...	Zone 1, 2, 21, 22

↑ Sensor length * at 50 mm length -40...+80 °C

Product views and applications

...Cos-D... transmitter



ExPro-C... sensors

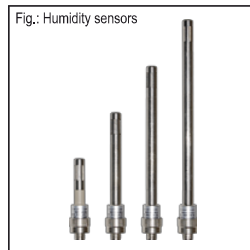

...Cos-D...-CT



...Cos-D...-VA



Duct or room sensor



Description

The ExCos-D... transmitter generation with directly coupled ExPro-C... sensors are a revolution for measuring temperature and/or humidity in HVAC systems, in chemical, pharmaceutical, industrial and offshore/onshore plants, for use in hazardous areas zone 1, 2 (gas) and zone 21, 22 (dust).

Highest protection class (ATEX) and IP66 protection, small dimensions, universal functions and technical data guarantee safe operation even under difficult environmental conditions.

All sensors are programmable on site without any additional tools. The measuring ranges are scalable within the maximum ranges. The analogue output signal is either 0...10 VDC or (0)4...20 mA and can be selected on site. The integrated display (can be switched off as needed) is for parametrisation and an actual value indication at working mode.

...Cos-D-A transmitter are additionally equipped with two intrinsically safe (IS) outputs, e.g. for an external indicator.

Highlights

- ▶ For all types of gases, mists, vapours and dust for use in zone 1, 2, 21 and 22
- ▶ Power supply 24 VAC/DC
- ▶ Scalable analogue output, selectable 0...10 V / (0)4...20 mA
- ▶ Integrated Ex-e terminal box
- ▶ No additional Ex-i module required
- ▶ No intrinsically safe wiring/installation between panel and sensor required
- ▶ No intrinsically safe wiring/installation and no space in the panel required
- ▶ Optional IS output (0)4...20 mA for external indicator in Ex-areas
- ▶ Display with backlight, can be switched off
- ▶ Password locking
- ▶ Down to -20 °C ambient temperature applicable
- ▶ Compact design and small dimension
- ▶ Robust aluminium housing (optional with seawater resistant coating) or in stainless steel
- ▶ IP66 protection

ExPro-C – see additional data sheet



Technical data

Supply voltage, frequency	24 VAC/DC $\pm 20\%$ (19,2...28,8 VAC/DC), 50/60 Hz
Current, power consumption	150 mA, ~ 4 W, internal fuse 500 mA, without bracket, not removable
Galvanic isolation	Supply for analogue in- and outputs min. 1,5 kV, supply for relay output min. 1,5 kV
Electrical connection	Terminals 0,14...2,5 mm ² at integrated Ex-e terminal box, stripping length 9 mm, torque 0,4...0,5 Nm, equipotential bonding 4 mm ²
Cable glands	2 x M16 x 1,5 mm, Ex-e approved, for cable diameter ~ \varnothing 5...9 mm
Cable glands ...-CT	2 x M16 x 1,5 mm, Ex-e approved, brass nickel-plated, for cable diameter ~ \varnothing 6...10 mm
...-VA	2 x M20 x 1,5 mm, Ex-e approved, brass nickel-plated, for cable diameter ~ \varnothing 6...13 mm
Protection class	Class I (grounded)
Display	2 x 16 digits, dot-matrix display, backlit, for configuration, user guidance, parameter and actual value indication
Control elements	3 buttons for configuration
Housing material	Aluminium die-cast housing, coated, Optional with seawater resistant coating (...-CT) or stainless steel housing, № 1.4581 / UNS-J92900 / similar AISI 316Nb (...-VA)
Dimensions (L x W x H)	Aluminium housing ~ 180 x 107 x 66 mm, stainless steel housing ~ 195 x 127 x 70 mm (each without connectors)
Weight	~ 950 g aluminium housing, stainless steel version ~ 2,5 kg
Ambient temperature	-20...+50 °C, storage temperature -35...+70 °C
Temperature class	Aluminium housing T6 (T80 °C) at -20...+50 °C Stainless steel housing T5 (T95 °C) at -20...+40 °C, T4 (T130 °C) at -20...+50 °C
Ambient humidity	0...95 % rH, non condensing
Sensor connection	For ExPro-C... sensor only! Via plug and socket connection at front side (for room mounting) or at back side (for duct mounting). Attention: Only 1 ExPro-C... sensor per transmitter can be connected!
ExPro-C... sensors	More information of connectable ExPro-C... sensors see separate data sheet
Measuring ranges adjustable	Measuring ranges are scalable within and limited by the maximum sensor measuring range
Response time of sensor	T90 / ~ 1 s
Start delay	5 s
Stability	Long term stability < 0,2 %/year, temperature influence < 0,02 %/K, supply voltage influence < 0,01 %
Output	Voltage U [V] or current I [mA] selectable via menu on site (with combi sensors not adjustable separately), protected against short circuit and external voltage up to 24 V, protected against polarity reversal
Voltage output U	0...10 V adjustable, invertible, burden > 1 k Ω , influence < 0,05 %/100 Ω + accuracy of ...Pro-C... sensor
Current output I	0...20 mA adjustable, invertible, burden < 500 Ω , influence < 0,1 %/100 Ω , open circuit voltage < 24 V + accuracy of ...Pro-C... sensor
Output in alarm mode	Increasing or decreasing output signal, selectable on site, down to 0 VDC/0 mA or up to 10 VDC/20 mA
Wiring diagram	SB 2.0
Scope of delivery	Transmitter, 3 self-tapping screws 4,2 x 13 mm resp. in stainless steel (with ...-CT and ...-VA versions) ...Cos-D-A with 2 additional plugs for cable diameter \varnothing 6...8 mm
Parameter at delivery	Output 4...20 mA, output in alarm mode decreasing to 0 V/0 mA
ExCos-D-A	as above and 2 additional intrinsically safe analogue outputs
Ex-i analogue output	2 x (0)4...20 mA, intrinsically safe (IS), burden max. 400 Ω
Accuracy	$\pm 0,5\%$
Wiring diagram	SB 3.2

Approbations

ATEX directive	2014/34/EU
EC type-approved	EPS 14 ATEX 1 655 X
IECEX certified	IECEX EPS 14.0022X
Approval for gas	II 2 (1) G Ex e ma [ia Ga] IIC T6...T4 Gb Types ...-CT, ...-OCT II 2 (1) G Ex e ma [ia Ga] IIB T6 Gb
Approval for dust	II 2 (1) D Ex tb [ia Da] IIIC T80°C...T130°C Db IP66
CE identification	CE № 0158
EMC directive	2014/30/EU
Enclosure protection	IP66 in acc. with EN 60529
EAC	TC RU C-DE.ГБ08.01510

Special solutions and accessories

...-CT	Types in aluminium housing with seawater resistant coating, parts nickel-plated
...-VA	Types in stainless steel housing, parts nickel-plated
EXC-RIA-16	LCD indicator (IS) for Ex-/RedCos... sensors in Ex-zones 1, 2, 21, 22
MKR	Mounting bracket for round ducts up to \varnothing 600 mm
Kit-S8-CBR	2 cable glands M16 x 1,5 mm, Ex-e, brass nickel-plated, for cable \varnothing 5...10 mm
VL3	Sensor extension cable, 3 m



Electrical connection

All transmitters require a 24 VAC/DC power supply. The electrical wiring must be realized via the integrated Ex-e terminal box acc. to ATEX. The terminals' type of protection is "Increased safety Ex-e".

Attention: Before opening the terminal box cover, the supply voltage must be shut off! The supply has to be connected at terminals 1 (-/-) and 2 (+/+), the analogue output for temperature sensors at terminals 3 (mA/V) and 4 (GND), for humidity sensors at terminals 5 (mA/V) and 4 (GND).

The additional analogue output at ...Cos-D-A is intrinsically safe. Note the maximum connection values of intrinsically safe parameters (see table below).

Depending on the ...Pro-C... sensor's type you can measure either temperature (...Pro-CT...) or humidity (...Pro-CF...) at the time or combined with a ...Pro-CTF... Simultaneous measurings are not possible, use only one transmitter at the time.

Before starting parametrisation of ...Cos-D... transmitter a ...Pro-C... sensor must be connected, which can be mounted either to the front or the back side of the transmitter. The protective cap must be removed.

Unused connectors must be covered with the original protective cap to avoid mechanical damage and dirt!

Depending on the sensor's type you need to set parameters for one or two measuring ranges and their related data.

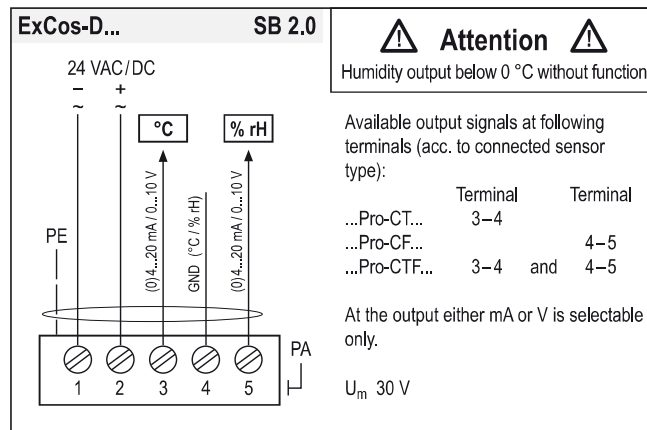

Intrinsically safe parameters (IS) – For external ExPro-C... sensor

U_o = 7.9 V C_i → 0
I_o = 48 mA L_i → 0
P_o = 95 mW

	IIC	IIB	IIA
L _o	2 mH	5 mH	10 mH
C _o	1.3 µF	5.8 µF	7.1 µF

Ex-i output (IS) (optional) – ExCos-D-A...

Connector and terminals

SB 3.2

Female connector

Male connector

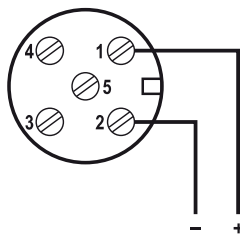
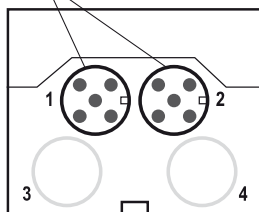

Output 1: for temperature sensor [°C]
Output 2: for humidity sensor [% rH]

to connect e.g.
an external LCD indicator (IS)

Intrinsically safe parameters (IS) – Analogue Ex-i output

U_o = 15.8 V C_i → 0
I_o = 85 mA L_i → 0
P_o = 336 mW

	IIC	IIB	IIA
L _o	2 mH	5 mH	10 mH
C _o	0.33 µF	1.6 µF	1.8 µF

Display, buttons and parameters

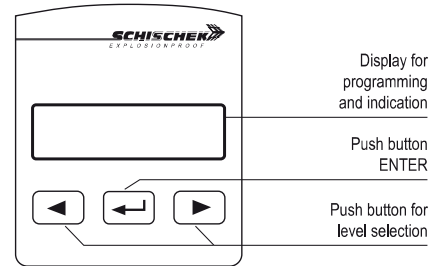

Change operation – parametrisation mode

To change from operation to parametrisation mode and vice versa, push ENTER button for minimum of 3 seconds. Back to operation mode with menu "save".

Indication of data logging

A flashing star in the display shows that data is received and the device is working.

Password input

The default/delivery setup is 0000. In this configuration the password input is not activated. To activate the password protection (menu 20) change the 4 digits into your choosen numbers (e.g. 1234) and press ENTER.

Please keep your password in mind for next parameter change! Due to a new parameter setup the password is requested.

Important information for installation and operation

A. Installation, commissioning, maintenance

All national and international standards, rules and regulations must be complied with. Certified apparatus must be installed in accordance with manufacturer instructions. If the equipment is used in a manner not specified by the manufacturer, the safety protection provided by the equipment may be impaired. For electrical installations design, selection and erection, EN/IEC 60079-14 can be used.

Attention: Apply all Ex rules and regulation before opening the internal terminal box. Do not open cover when circuits are live!

Draw the wiring cables through the cable glands. For connection use the internal Ex-e approved terminal box and connect equipotential bonding.

After connection install the cables in a fixed position and protect them against mechanical and thermal damage. Close all openings and ensure IP protection (min. IP66).

Avoid temperature transfer and ensure not to exceed max. ambient temperature! For outdoor installation a protective shield against sun, rain and snow should be applied. Sensors are maintenance free. An annual inspection is recommended. For electrical installations inspection and maintenance, EN/IEC 60079-17 can be used.

Clean with damp cloth only.

Ex sensors must not be opened and repaired by the end user.

B. Long cabling

We recommend using shielded signal wires and to connect one end of the shield to the ...Cos... terminal box.

C. Separate ground wires

For supply and signal wires use separate grounds.

D. ExPro-C... sensors

The ExPro-C... sensor is supplied by the transmitter's intrinsically safe circuit. Unused connectors must be covered with a protective cap.



Parametrisation and commissioning

To change from operation to parametrisation mode push the "ENTER" button for minimum 3 seconds.
If password protected: type password and push .
Skip menu with , back to operation mode with menu "Save and exit".

Operation → Parametrisation
push for min. 3 s

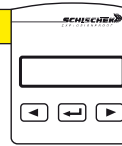

Example:
Menu language English
Ranges 0...50 °C, 0...100 % rF
Output ranges 0...10 V, 0...10 V
Output Ex-i 0...20 mA

Menu	Function	ENTER	Indication	Select	ENTER	Next indication	Select	ENTER	Next menu
Menu 1	DE, EN, FR Select language: German, English, French		DE, EN, FR English deutsch, english, francais						
Menu 2	no function – menu skip								
Menu 3	no function – menu skip								
Menu 4	Unit sensor 1 Select physical unit		unit sensor 1 °C °C, °F						
Menu 5	Range 1 Adjust the measuring range		range 1 0...50 °C ← adjust lower limit			range 1 0...50 °C ← adjust higher limit			
Menu 6	no function – menu skip								
Menu 7	Output V mA Select output signal		output V mA mA V, mA						
Menu 8	Output range 1 Adjust output range		output range 1 0...10 mA ← adjust lower limit			output range 1 0...10 mA ← adjust higher limit			
Menu 9	Sensor error 1 Select output signal at sensor error		sensor error 1 10 V/20 mA 10 V/20 mA, 0 V/0 mA						
Menu 10	Output 1 Select signal output behaviour		output 1 increasing increasing, decreasing						
Menu 11	Unit sensor 2 * (humidity) Select physical unit		unit sensor 2 % rF % rF, % rH						
Menu 12	Range 2 * Adjust the measuring range		range 2 0...100 % rF ← adjust lower limit			range 2 0...100 % rF ← adjust higher limit			
Menu 13	Output range 2 * Adjust output range		output range 2 0...10 V ← adjust lower limit			output range 2 0...10 V ← adjust higher limit			
Menu 14	Sensor error 2 * Select output signal at sensor error		sensor error 2 0 V/0 mA 0 V/0 mA, 10 V/20 mA						
Menu 15	Output 2 * Select signal output behaviour		output 2 increasing increasing, decreasing						
Menu 16	Output Ex-i 1 (optional ...Cos-D-A) Select lower output signal: 0 mA resp. 4 mA (0...20 or 4...20 mA)		output Exi 1 0...20 mA ← adjust lower limit			output Exi 1 0...20 mA ← adjust higher limit			
Menu 17	Output Ex-i 2 (optional ...Cos-D-A) * Select lower output signal: 0 mA resp. 4 mA (0...20 or 4...20 mA)		output Exi 2 0...20 mA ← adjust lower limit			output Exi 2 0...20 mA ← adjust higher limit			
Menu 18	no function – menu skip								
Menu 19	Display function Select display		display function on illuminated on illuminated, off, on						
Menu 20	Password Select password protection		new password yes no Ja			password 0000 push to change position			
Menu 21	Save and exit Select: save data, factory setting, discard or back to menu		save and exit save data save data, factory setting, discard, back to menu			(operation mode after "save data")			
Menu 22	Set offset 1 Add/subtract offset from measure value temperature		set offset 1 +0.01 °C						
Menu 23	Set offset 2 * Add/subtract offset from measure value humidity		set offset 2 -0.02 % rH						

* with combination sensor ...Pro-CTF only



Dimensions [mm]

Aluminium housing

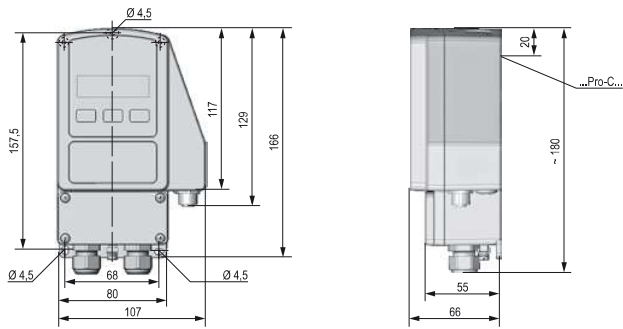

Stainless steel housing

